



kW PS CC Cyl

Accord IV (CB)						01.90 - 03.93	68300	67300	33412	39130	54320	54689	94692		
Accord V (CC7)	2.0 i	85	116	1997	4	F20Z2	03.93 - 01.96	58305	57305	33574	39002	53791	54187	94802	35993
Accord V (CC7)	2.0 i S	96	131	1997	4	F20Z1	03.93 - 01.96	58305	57305	33569	39002	53791	54187	94802	35993
Accord V (CC7)	2.3 i SR	116	158	2259	4	H23A3	03.93 - 01.96	58305	57305	33574	39002	53791	54187	94802	35993
Accord V coupé	2.0 (DC9)	100	136	1997	4	F20B3	09.93 - 12.97	58305	57305	33574	39002	53915	54187	94802	35993
Accord V coupé	2.2 i ES	110	150	2156	4	F22B5	09.93 - 02.98	58305	57305	33574	39002	53915	54187	94802	35993
Accord VI (CE,CF)	1.9 i (CE7)	85	116	1850	4	F18A3	02.96 - 10.98	58305	57305	33574	39002	43000	54187	94802	35993
Accord VI (CE,CF)	2.0 i LS (CE8)	96	131	1997	4	F20Z1	02.96 - 10.98	58305	57305	33574	39002	43000	54187	94802	35993
Accord VI (CE,CF)	2.2 i VTEC (CE9)	110	150	2156	4	F22Z2	02.96 - 10.98	58305	57305	33574	39002	53791	54187	94802	35993
Accord VI (CE,CF)	2.0 TDi (CF1)	77	105	1994	4	20T2N	04.96 - 10.98	58713	57713		39002	53788	54187	94802	35993
Accord VII (CG)	1.6 i	85	116	1590	4	D16B6	10.98 -	58733	57733	83003	39000			93063	35993
Accord VII (CG)	1.8 i	100	136	1850	4	F18B2	10.98 -	98838		83003	39000			93063	35993
Accord VII (CG)	2.0 i	108	147	1997	4	F20B6	10.98 - 01.01	98838		83003	39000			93063	35993
Accord VII (CG)	2.2 Type-R	156	212	2157	4	H22A7	02.99 -	58732	57732	83003	39000			93063	35993
Accord VII (CG)	2.0 Turbo DI	77	105	1994	4		02.99 -			83003	39000			93063	35993
Accord VII (CG)	2.3	113	154	2254	4		01.01 -	98838		83003	39000			93063	35993
Accord VII coupé (CG)	2.0 i 16V	108	147	1997	4	F20B5	02.98 -	98838		83003	39000			93063	35993
Accord VII coupé (CG)	3.0 V6 24V	147	200	2997	6	J30A1	02.98 - 01		77341	83003	39000			93063	35993
Accord VII coupé (CG)	3.0 V6 24V	147	200	2997	6	J30A1	02 -		77383	83003	39000			93070	35993
Accord VIII	2.0 (CL7)	114	155	1998	4	K20A	02.03 -	58881	57881		39021				20945
Accord VIII	2.0 (CL8)	114	155	1998	4	K20A	02.03 -	58881	57881		39021				20945
Accord VIII	2.4 (CL9)	140	190	2354	4		02.03 -	78389	77389		39021				20945
Accord VIII	2.2 i-CTDi	103	140	2204	4		01.04 -				39021				43255
Accord VIII Tourer	2.0 (CM1)	114	155	1998	4	K20A	04.03 -	58881	57881		39021				43179
Accord VIII Tourer	2.4 (CM2)	140	190	2354	4	K24A	04.03 -	78389	77389		39021				43179
Accord VIII Tourer	2.2 i-CTDi	103	140	2204	4	N22A1	01.04 -				39021				43255
Civic III (EC, ED, EE)	1.3 (EC8)	55	75	1343	4	D13B1	10.87 - 12.89			33823		54316	54658	94749	
Civic III (EC, ED, EE)	1.3 16 V (EC8) KAT	55	75	1343	4	D13B2	09.89 - 09.91			33823		54316	54658	94749	
Civic III (EC, ED, EE)	1.4 L (EC9)	66	90	1396	4	D14A1	10.87 - 12.89			33823		54316	54658	94749	
Civic III (EC, ED, EE)	1.5 i 16V	66	90	1493	4	D15B2	10.88 - 09.91			33278	38872	54316	54658	94749	
Civic III (EC, ED, EE)	1.5 i 16V	66	90	1493	4	D15B2	10.88 - 09.91		57570	33278	38631	54316	54658	94749	
Civic III (EC, ED, EE)	1.5 i 16V (ED6)	69	94	1493	4	D15B2	10.88 - 09.91			33278	38872	54316	54658	94749	
Civic III (EC, ED, EE)	1.5 i 16V (ED6)	69	94	1493	4	D15B2	10.88 - 09.91		57570	33278	38631	54316	54658	94749	
Civic III (EC, ED, EE)	1.6 i 16V (ED7)	80	109	1590	4	D16A6	10.87 - 09.91			33278	38872	54316	54658	94749	
Civic III (EC, ED, EE)	1.6 i 16V (ED7)	80	109	1590	4	D16A6	10.87 - 09.91		57570	33278	38631	54316	54658	94749	
Civic III (EC, ED, EE)	1.6 i 16V (ED7)	81	110	1590	4	D16Z2	10.87 - 09.91			33278	38872	54316	54658	94749	
Civic III (EC, ED, EE)	1.6 i 16V (ED7)	81	110	1590	4	D16Z2	10.87 - 09.91		57570	33278	38631	54316	54658	94749	



kW PS CC Cyl

Civic III (EC, ED, EE)	1.6 i 16V	96	130	1590	4	D16A7	09.87 - 09.91			33278	38872	54316	54658	94749
Civic III (EC, ED, EE)	1.6 i 16V	96	130	1590	4	D16A7	09.87 - 09.91	57570		33278	38631	54316	54658	94749
Civic III (EC, ED, EE)	1.6 i 16V Vtec (EE9)	110	150	1595	4	B16A1	10.89 - 09.91			33278	38872	54316	54658	94749
Civic III (EC, ED, EE)	1.6 i 16V Vtec (EE9)	110	150	1595	4	B16A1	10.89 - 09.91	57570		33278	38631	54316	54658	94749
Civic IV (EG, EH)	1.5 i 16V (EG8)	69	94	1493	4	D15B2, D15Z1	10.91 - 11.95	58341	57341	33588		53912	54167	94750
Civic IV (EG, EH)	1.5 i 16V (EG8)	69	94	1493	4	D15B2, D15Z1	10.91 - 11.95			33588	38631	53912	54167	94750
Civic IV (EG, EH)	1.5 i 16V (EG8)	69	94	1493	4	D15B2, D15Z1	10.91 - 93			33588	38631	53937	54691	94750
Civic IV (EG, EH)	1.6 16V Vtec (EH9)	92	125	1590	4	D16Z6	10.91 - 11.95	58341	57341	33588		53912	54167	94750
Civic IV (EG, EH)	1.6 16V Vtec (EH9)	92	125	1590	4	D16Z6	10.91 - 11.95			33588	38631	53912	54167	94750
Civic IV (EG, EH)	1.6 16V Vtec (EH9)	92	125	1590	4	D16Z6	10.91 - 93			33588	38631	53937	54691	94750
Civic IV (EG, EH)	1.6 VTi (EG9)	118	160	1595	4	B16A2	10.91 - 11.95	58341	57341	33588		53912	54167	94750
Civic IV (EG, EH)	1.6 VTi (EG9)	118	160	1595	4	B16A2	10.91 - 11.95			33588	38631	53912	54167	94750
Civic IV (EG, EH)	1.6 VTi (EG9)	118	160	1595	4	B16A2	10.91 - 93			33588	38631	53937	54691	94750
Civic IV (EJ)	1.5 i LSi (EJ2)	74	101	1493	4	D15B7	01.94 - 11.95			33588	38631	53912	54167	94750
Civic IV (EJ)	1.6 i (EJ6)	77	105	1590	4	D16Y7	01.94 - 11.95			33588	38631	53912	54167	94750
Civic IV (EJ)	1.6 i Vtec (EJ1)	92	125	1590	4	D16Y6, D16Z9	01.94 - 11.95			33588	38631	53912	54167	94750
Civic IV (EJ)	1.6 i Vtec	118	160	1595	4	B16A2	01.94 - 11.95			33588	38631	53912	54167	94750
Civic V Hatchback	1.4 i (EJ9)	55	75	1396	4	D14A3	11.95 - 02.01	68571	77560	33595	39000	53911	54296	94799
Civic V Hatchback	1.4 i S (EJ9)	66	90	1396	4	D14A4	11.95 - 02.01	68571	77560	33595	39000	53911	54296	94799
Civic V Hatchback	1.5 i (EK3)	84	114	1493	4	D15Z6	11.95 - 02.01	68571	77560	33595	39000	53911	54296	94799
Civic V Hatchback	1.6 i (EK1)	84	114	1590	4	D16Y5	11.95 - 02.01	68571	77560	33595	39000	53911	54296	94799
Civic V Hatchback	1.6 VTi (EK4)	118	160	1595	4	B16A2	11.95 - 02.01	68571	77560	33595	39000	53911	54296	94799
Civic V (MB)	1.4 16V (MB2)	55	75	1396	4	D14A7	01.97 - 02.01	68571	77560	33595	39000	53911	54296	94799
Civic V (MB)	1.4 16V (MB2)	66	90	1396	4	D14A8	01.97 - 02.01	68571	77560	33595	39000	53911	54296	94799
Civic V (MB)	1.5 16V (MB3)	84	114	1493	4	D15Z8	01.97 - 02.01	68571	77560	33595	39000	53911	54296	94799
Civic V (MB)	1.6 16V (MB4)	85	116	1590	4	D16B2	01.97 - 02.01	68571	77560	33595	39000	53911	54296	94799
Civic V (MB)	1.6 VTi	118	160	1595	4	B16A2	01.97 - 02.01	68571	77560	33595	39000	53911	54296	94799
Civic V (MB)	1.8 16V (MB6)	124	169	1797	4		01.97 - 02.01					53911	54296	94799
Civic V (MB)	2.0 i TD (MB7)	63	86	1994	4		01.97 - 02.01	58713	57713			53911	54296	94799
Civic V Aerodeck (MC)	1.4 16V (MB8)	55	75	1396	4	D14A7	04.98 - 02.01			33595	39000	53911	54296	94799
Civic V Aerodeck (MC)	1.4 16V (MB8)	66	90	1396	4	D14A8	04.98 - 02.01			33595	39000	53911	54296	94799
Civic V Aerodeck (MC)	1.5 16V (MB9)	84	114	1493	4	D15Z8	04.98 - 02.01	68571	77560	33595	39000	53911	54296	94799
Civic V Aerodeck (MC)	1.6 16V (MC1)	85	116	1590	4	D16B2	04.98 - 02.01			33595	39000	53911	54296	94799
Civic V Aerodeck (MC)	1.8 16V (MC2)	124	169	1797	4	B18C4	04.98 - 02.01					53911	54296	94799
Civic V Aerodeck (MC)	2.0 i D (MC3)	77	105	1994	4		04.98 - 02.01	58713	57713			53911	54296	94799
Civic VI (EU_, EP_)	1.4 i	55	75	1396	4		02.01 -	78592	77592	83008	39007	53522	54738	93061
Civic VI (EU_, EP_)	1.4 i	55	75	1396	4		02.01 -	68054	77599	83008	39007	53522	54870	93061
Civic VI (EU_, EP_)	1.4 iS	66	90	1396	4		02.01 -	78592	77592	83008	39007	53522	54738	93061
Civic VI (EU_, EP_)	1.4 iS	66	90	1396	4		02.01 -	68054	77599	83008	39007	53522	54870	93061



		kW	PS	CC	Cyl								
<i>Civic VI (EU_, EP_)</i>	1.6 i	81	110	1590	4	02.01 -	78592	77592	33595	39007	53522	54738	93061
<i>Civic VI (EU_, EP_)</i>	1.6 i	81	110	1590	4	02.01 -	68054	77599	33595	39007	53522	54870	93061
<i>Civic VI (EU_, EP_)</i>	2.0 i Sport	118	160	1998	4	01.04 -				39020			93061
<i>Civic VI (EU_, EP_)</i>	2.0 Type-R	147	200	1998	4	09.01 -	78592	77592	83008	39007		54738	93061
<i>Civic VI (EU_, EP_)</i>	2.0 Type-R	147	200	1998	4	09.01 -	68054	77599	83008	39007		54870	93061
<i>Civic VI (EU_, EP_)</i>	1.7 CTDi	74	100	1686	4	01.02 -		97880		39007	43358		93061
<i>Civic VI</i>	1.3 IMA	61	83	1339	4	01.04 -		77552		39020			93061
<i>Civic VI</i>	1.4	66	90	1396	4	02.01 -				39006		54898	93061
<i>Civic VI</i>	1.6	81	110	1590	4	02.01 -				39006		54898	93061
<i>Civic VI</i>	1.7	85	116	1668	4	02.01 -		77613		39006		54898	93061
<i>Civic VI coupé (EM)</i>	1.6 i	81	110	1590	4	02.01 -				39006		54898	93061
<i>Civic VI coupé (EM)</i>	1.7 i	88	120	1668	4	05.01 -		77613		39006		54898	93061
<i>Civic VI coupé (EM)</i>	1.7 i VTEC	92	125	1668	4	05.01 -		77613		39006		54898	93061
<i>Civic VII Hatchback</i>	1.3	70	95	1339	4 LDA2	01.06 -					43334		
<i>Civic VII Hatchback</i>	1.4	61	83	1339	4 L13A7	01.06 -					43334		
<i>Civic VII Hatchback</i>	1.8	103	140	1799	4 R18A2	01.06 -					43334		
<i>Civic VII Hatchback</i>	2.2 CTDi	103	140	2204	4 N22A2	01.06 -	98869	97869			43334		
<i>CR-V I (RD)</i>	2.0 16V (RD1, RD3)	94	128	1973	4 B20B	10.95 - 06.97			83003	39000	53434	54296	35993
<i>CR-V I (RD)</i>	2.0 16V (RD1, RD3)	94	128	1973	4 B20B	07.97 - 01.99	68571	77560	83003	39000	53434	54296	93060 35993
<i>CR-V I (RD)</i>	2.0 16V (RD1, RD3)	108	147	1973	4	01.99 -	68571	77560	83003	39000	53434	54296	93060 35993
<i>CR-V II</i>	2.0	110	150	1998	4	07.02 -	58881	57881	83019	39006	43178	54898	35993
<i>CR-V II</i>	2.4					07.02 -	58881	57881	83019	39006	43178	54898	35993
<i>CRX II (ED, EE)</i>	1.6 i 16V (ED9)	91	124	1590	4 D16Z5	10.87 - 02.92			33278	38872		54658	94749
<i>CRX II (ED, EE)</i>	1.6 i 16V (ED9)	96	131	1590	4 D16A9	10.87 - 12.89			33278	38872		54658	94749
<i>CRX II (ED, EE)</i>	1.6 i 16V Vtec (EE8)	110	150	1595	4 B16A1	10.89 - 02.92			33278	38872		54658	94749
<i>CRX III (EH, EG)</i>	1.6 ESi (EH6)	92	125	1590	4 D16Z6	03.92 - 12.98					53912		94749
<i>CRX III (EH, EG)</i>	1.6 i VTi (EG2)	118	160	1595	4 B16A2	03.92 - 12.98					53912		94749
<i>FR-V</i>	1.7	92	125	1668	4 D17A2	02.05 -		97868					
<i>FR-V</i>	2.0	110	150	1998	4 K20A9	02.05 -		97868					
<i>FR-V</i>	2.2 i CTDi	103	140	2204	4	07.05 -					43359		
<i>HR-V (GH)</i>	1.6 16V	77	105	1590	4 D16W1	03.99 -						54296	
<i>HR-V (GH)</i>	1.6 16V 4WD	77	105	1590	4 D16W1	03.99 -						54296	
<i>HR-V (GH)</i>	1.6 16V 4WD	91	124	1590	4	10.99 -						54296	
<i>Jazz (GD)</i>	1.2	57	78	1243	4	03.02 -	98878	97878			43121		
<i>Jazz (GD)</i>	1.4	61	83	1339	4	03.02 -	98878	97878			43121		



kW PS CC Cyl

Legend (HS, KA) 2.5 i	2.5 i (HS)	110	150	2494	C25A1	01.86 - 12.87	57363	33412	38616	53151	94754		
Legend (HS, KA) 2.5 i	2.5 i (HS)	127	173	2494	C25A2	02.87 - 06.88	57363	33412	38616	53151	94754		
Legend (HS, KA) 2.7 i	2.7 i 24V (KA4)	124	169	2675	C27A1	01.88 - 12.90	57363	33412	38616	53151	94754		
Legend Coupe (KA3)	2.7 i 24V	124	169	2675	C27A1	10.87 - 12.90	57364	33412	38616	53151	94754		
Legend II (KA7)	3.2 i 24V	151	205	3206	6 C32A2	01.91 - 02.96	77328	33589	39131		54721		
Legend II (KA7)	3.2 i 24V	151	205	3206	6 C32A2	01.91 - 02.96	77328	33589	39131		54706		
Legend III (KA9)	3.5 i 24V	151	205	3474	6 C35A2	02.96 -							
Logo (GA3)	1.3	48	65	1343	4 D13B7	03.99 - 03.02		83003					
NSX Coupé (NA)	3.0 24V Vtec	188	256	2977	6 C30A4	06.90 -	57375						
NSX Coupé (NA)	3.0 24V Vtec	201	274	2977	6 C30A3	06.90 -	57375						
NSX Coupé (NA)	3.2 24V Vtec	206	280	3179	6	01.97 -	57375						
NSX Cabrio (NA)	3.0 24V Vtec	188	256	2977	6 C30A4	03.95 -	57375						
NSX Cabrio (NA)	3.0 24V Vtec	201	274	2977	6 C30A3	03.95 -	57375						
NSX Cabrio (NA)	3.2 24V Vtec	206	280	3179	6	01.97 -	57375						
Prelude III (BA)	2.0 EX (BA4)	80	109	1958	4 B20A3	04.87 - 01.92	57494	33426	38872	54362	54671	94693	
Prelude III (BA)	2.0 (BA4)	84	114	1958	4 B20A4	08.87 - 01.92	57494	33426	38872	54362	54671	94693	
Prelude III (BA)	2.0 i EX 16V	101	137	1958	4 B20A1	04.86 - 12.87	57494		38872	54362	54671	94693	
Prelude III (BA)	2.0 i EX 16V	101	137	1958	4 B20A5	04.87 - 01.92	57494	33426	38872	54362	54671	94693	
Prelude III (BA)	2.0 i EX 16V	103	140	1958	4 B20A9	04.90 - 01.92	57494	33426	38872	54362	54671	94693	
Prelude III (BA)	2.0 i EX 16V	101	137	1958	4 B20A1	04.86 - 12.87	57494		38872	54362	54671	94693	
Prelude III (BA)	2.0 i EX 16V	110	150	1958	4 B20A7	10.87 - 12.90	57494	33426	38872	54362	54671	94693	
Prelude IV (BB)	2.0 i 16V (BB3)	98	133	1997	4 F20A4	02.92 - 09.96	68553	67553	33577	38631	53913	54709	35993
Prelude IV (BB)	2.0 i 16V (BB3)	98	133	1997	4 F20A4	02.92 - 09.96		67554	33577	38631	53913	54709	35993
Prelude IV (BB)	2.2 i 16V Vtec (BB1)	136	185	2157	4 H22A2	02.93 - 09.96	68553	67553	33577	38631	53913	54709	35993
Prelude IV (BB)	2.2 i 16V Vtec (BB1)	136	185	2157	4 H22A2	02.93 - 09.96		67554	33577	38631	53913	54709	35993
Prelude IV (BB)	2.3 i 16V (BB2)	118	160	2259	4 H23A2	02.92 - 09.96	68553	67553	33577	38631	53913	54709	35993
Prelude IV (BB)	2.3 i 16V (BB2)	118	160	2259	4 H23A2	02.92 - 09.96		67554	33577	38631	53913	54709	35993
Prelude V (BB)	2.0 16V (BB9)	98	133	1997	4 F20A4	10.96 -	58878	57878	33574	39090	43001	35993	
Prelude V (BB)	2.2 16V (BB6, BB8)	136	185	2157	4 H22A5	10.96 -	58878	57878	33574	39090	43001	35993	
Prelude V (BB)	2.2 16V	147	200	2157	4 H22A5	10.96 -	58878	57878	33574	39090	43001	35993	
Shuttle (RA)	2.2 16V	110	150	2156	4 F22B8	10.94 - 02.98	58305	57305	33596		53524	54690	20947
Shuttle (RA)	2.3 16V	110	150	2254	4 F23A7	01.98 - 05.01	98938	67315		39005	53524	54690	
Stream (RN)	1.7 16V	92	125	1668	4	05.01 -	77613						
S2000 (AP)	2.0	177	240	1997	4 F20C VTEC	06.99 -		33595		43001		35993	



4 SEASONS

NEW: **58305**
RMFG: **57305**Ø 152 mm
Poly-V6
190 cc
Nippondenso 10PA17C

38810-P1E-003 / 38810-P1E-999

4 SEASONS

NEW: **58341**
RMFG: **57341**Ø 152 mm
Poly-V6
190 cc
Nippondenso 10PA15C

38810-PW0-N01

4 SEASONS

NEW: **58713**
RMFG: **57713**Ø 126 mm
Poly-V6
135 cc
Sanden 7V16

38810-PST-G20 / 38810-P9M-E30

4 SEASONS

NEW: **58732**
RMFG: **57732**Ø 112 mm
Poly-V6
130 cc
Sanden TRSA09

38810-PDE-E02 / 38800-PDE-E010

4 SEASONS

NEW: **58733**
RMFG: **57733**Ø 106 mm
Poly-V4
130 cc
Sanden TRSA09

38810-PDF-E02

4 SEASONS

NEW: **58878**
RMFG: **57878**Ø 112 mm
Poly-V6
130 cc
Keihin HS090

38810-P5M-006 / 38810-P5M-016

4 SEASONS

NEW: **58881**
RMFG: **57881**Ø 118 mm
Poly-V7
180 cc
Keihin HS-110R

38810-PNB-006

4 SEASONS

NEW: **68054**
RMFG: **77599**Ø 114 mm
Poly-V6
130 cc
Sanden TRSA09

38810-PLM-A11

4 SEASONS

NEW: **68300**
RMFG: **67300**Ø 165 mm
Poly-V5
190 cc
Nippondenso 10PA17C

38810-PT0-013

4 SEASONS

NEW: 68553
RMFG: 67553



Ø 127 mm
Poly-V5
130 cc
Sanden TRF090

38810-P13-016 / 38810-POG-AO1 / 38810-PTO-013 / 38810-SSO-AO1 / 38900-POG-AO1

4 SEASONS

NEW: 68571
RMFG: 77560



Ø 112 mm
Poly-V4
130 cc
Sanden TRSA090

38810-P2A-006 / 38810-P06-A04

4 SEASONS

NEW: 78389
RMFG: 77389



Ø 130 mm
Poly-V7
200 cc
Nippondenso 10S17C

447220-4863

4 SEASONS

NEW: 78592
RMFG: 77592



Ø 100 mm
Poly-V5
165 cc
Sanden TRS090

38810-POG-A01

4 SEASONS

NEW: 98838
RMFG: [REDACTED]



Ø 150 mm
Poly-V6
180 cc
Denso 10S17C

38810-PDA-E01 / 38810-P3G-003

4 SEASONS

NEW: 98869
RMFG: 97869

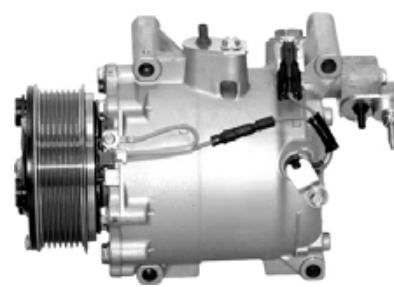

Ø 100 mm
Poly-V7
165 cc
Sanden TRSE07

38800-RSR-E010 / 38800-RSR-E010-M2 / 38800-RSRA-E020 / 38800-RSRA-E020-M2

4 SEASONS

NEW: 98938
RMFG: 67315



Ø 130 mm
Poly-V6
200 cc
Nippondenso 10PA17C

38810-P45-G02 / 38810-P8F-A01

4 SEASONS

NEW: 98878
RMFG: 97878



Ø 117 mm
Poly-V5
180 cc
Keihin

38810-PWA-006 / 38810-PWA-J02

4 SEASONS

NEW: [REDACTED]
RMFG: 57363



Ø 124 mm
Poly-V4
190 cc
Nippondenso 10P15C

38800-PH7-003

Non contractual pictures / photos non contractuelles / nicht vertragliche Fotos / fotografie non contrattuali / fotos no contractuales



4 SEASONS

NEW:
RMFG: 57364



∅ 121 mm
Poly-V4
190 cc
Nippondenso 10P17C

38810-PL2-003 / 38810-PL2-661

4 SEASONS

NEW:
RMFG: 57375



∅ 121 mm
Poly-V4
190 cc
Nippondenso 10PA15C

38800-PR4-A02

4 SEASONS

NEW:
RMFG: 57494



∅ 152 mm
Poly-V5
135 cc
Matsushita / Panasonic NL 1300

38810-PK2-M01

4 SEASONS

NEW:
RMFG: 57570



∅ 102 mm
Poly-V4
135 cc
Sanden TR70

38810-PM5-A01

4 SEASONS

NEW:
RMFG: 67554



∅ 121 mm
Poly-V4
130 cc
Sanden TRF090

38900-P13-JO2 / 79110-SSO-AO1

4 SEASONS

NEW:
RMFG: 77328



∅ 146 mm
Poly-V5
235 cc
Nippondenso 10PA20C

38810-PY3-043

4 SEASONS

NEW:
RMFG: 77341



∅ 131 mm
Poly-V6
190 cc
Nippondenso 10PA17C

38810-P8A-A01

4 SEASONS

NEW:
RMFG: 77383



∅ 127 mm
Poly-V6
200 cc
Nippondenso 10S17C

38810-P8E-A01

4 SEASONS

NEW:
RMFG: 77552

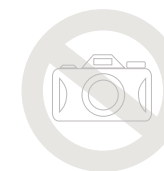

∅ 105 mm
Poly-V4
100 cc
Sanden TRSA090

38810-PZA-004

Non contractual pictures / photos non contractuelles / nicht vertragliche Fotos / fotografie non contractuali / fotos no contractuales

4 SEASONS **NEW:** **RMFG:** **77613**



∅ 108 mm
 Poly-V6
 130 cc
 Sanden TRSA09

38810-PLM-A12

4 SEASONS **NEW:** **RMFG:** **97868**



∅ 105 mm
 Poly-V6
 180 cc
 Keihin

38810-RJH-006 / HS-090L-4A

4 SEASONS **NEW:** **RMFG:** **97880**



∅ 105 mm
 Poly-V6
 165 cc
 Delphi CVC

3122161511 / 8972878761 / 8972878762 / 8972878763

4 SEASONS **43000**

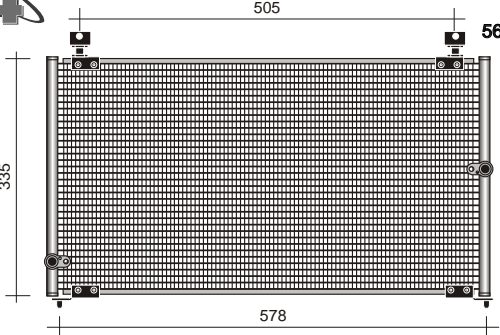

80100-SN7-E01

4 SEASONS **43001**

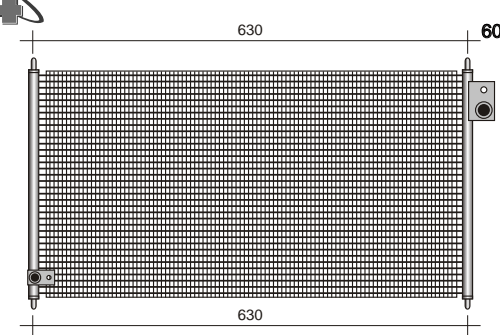

80100-S30-003

4 SEASONS **43121**



80110-SAA-013

4 SEASONS **43178**

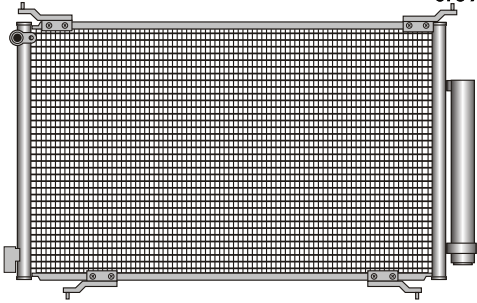

80110-S9A-003

4 SEASONS **43179**

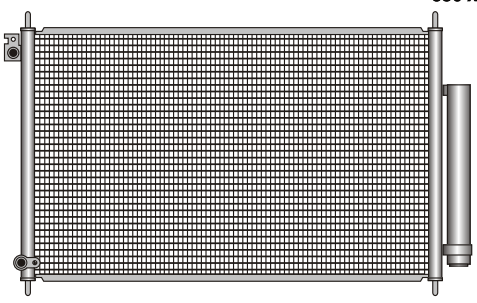

80110-SEA-003

4 SEASONS **43255**

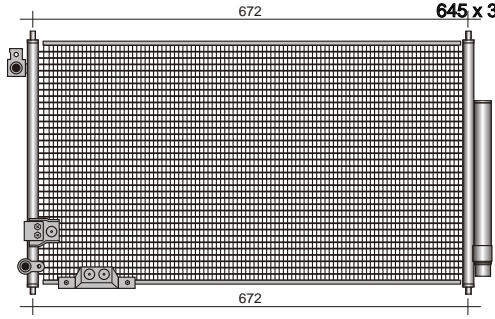

80101-SEF-E11

Non contractual pictures / photos non contractuelles / nicht vertragliche Fotos / fotografie non contrattuali / fotos no contractuales



4 SEASONS **43334**
 595
 590 x 338 x 16
 620
 80351-SMG-E01 / 80351-SMG-E02

4 SEASONS **43358**
 555
 505 x 335 x 19
 342
 530
 80100-S6FE-012 / 80110-S6F-E01

4 SEASONS **43359**
 620 x 367 x 16
 80110-SJH-E01

4 SEASONS **53151**
 600
 572 x 379 x 22
 220
 593
 80100-SD4-003

4 SEASONS **53398**
 628
 615 x 338 x 16
 628
 80100-S87-A00 / 80100-S87-A10

4 SEASONS **53409**
 630
 605 x 345 x 16
 80100-S84-A00 / 80110-S0A-003

4 SEASONS **53434**
 578
 595 x 318 x 22
 578
 80110-S10-003

4 SEASONS **53521**
 335
 592 x 360 x 16
 380
 630
 80110-S1A-G01 / 80110-S1A-G02

4 SEASONS **53522**
 632
 600 x 343 x 21
 B B
 17,00 mm
 A A
 12,00 mm
 632
 655
 80110-S6D-G01

Non contractual pictures / photos non contractuelles / nicht vertragliche Fotos / fotografie non contrattuali / fotos no contractuales

4 SEASONS **53524**
 605 x 320 x 16
 582
 302
 424
 582

80110-SX0-003

4 SEASONS **53788**
 570 x 290 x 18
 475
 305
 610
 ∅17mm.
 ∅14mm.

80100-S74-D10

4 SEASONS **53791**
 650 x 320 x 30
 615
 630
 16,41 mm
 7,33 mm
 16,49 mm
 7,33 mm
 12,20 mm

JRB100180

4 SEASONS **53911**
 330 x 350 x 20
 308
 243
 380
 62

80110-SO1-A11

4 SEASONS **53912**
 330 x 330 x 15
 15 mm
 10 mm
 240
 380

80110-SR1-A13 / 80110-SR1-023 / 80110-SR1-A23 / 80110-SR1A-123 /
 80110-SR3-0231

4 SEASONS **53913**
 600 x 321 x 22
 580
 580
 600

80110-SS0-A11 / 80110-SS0-A12 / 80110-SS0-000

4 SEASONS **53915**
 550 x 310 x 18
 578
 580
 600

80110-SV1-A11 / 80110-SV1-A21

4 SEASONS **53937**
 332 x 330 x 15
 4,8 mm
 7,1 mm
 ∅12,7 mm
 ∅6,5 mm

80110-SR-1A22

4 SEASONS **54316**
 616 x 258 x 22
 640
 630

80110-SH3-A1A

Non contractual pictures / photos non contrattuelles / nicht vertragliche Fotos / fotografie non contrattuali / fotos no contractuales



4 SEASONS

54320

640 x 305 x 23

632

16,8 mm

7,82 mm

16,66 mm

10,49 mm 5,20 mm

80100-SM1-A23

4 SEASONS

54362

645 x 320 x 22

630

115

103

80110-SF1-A1A

4 SEASONS

54167

241 x 229 x 80

80210-SR1-A12 / 80210-ST7-A21 / 80215-ST7-A01

4 SEASONS

54187

286 x 241 x 82

80211-SV1-A21

4 SEASONS

54296

231 x 238 x 80

80215-ST3-G11

4 SEASONS

54658

229 x 242 x 102

80210-SH3-A11

4 SEASONS

54671

203 x 241 x 101

80210-SF1-A21 / 80210-SF1-A22 / 80210-SF1-A01

4 SEASONS

54689

229 x 305 x 89

80210-SM1-A25 / 80210-SM1-A22 / 80210-SM1-A23 / 80210-SM1-A24

4 SEASONS

54690

292 x 292 x 60

80210-S0X-A01

Non contractual pictures / photos non contractuelles / nicht vertragliche Fotos / fotografie non contrattuali / fotos no contractuales

4 SEASONS



54691

240 x 225 x 78



R134a

80215-SR1-A21

4 SEASONS



54706

228 x 279 x 89

80210-SP0-A01

4 SEASONS



54709

216 x 280 x 89

80215-SS0-H01

4 SEASONS



54720

317 x 241 x 83

80210-SM1-Z01

4 SEASONS

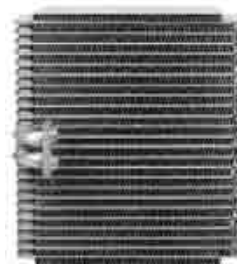

54721

241 x 270 x 86

80210-SP0-A01

4 SEASONS



54738

208 x 208 x 59

80215-S5D-G01

4 SEASONS



54870

260 x 234 x 75

80211-S6D-G11 / 80211-S6D-G12

4 SEASONS



54898

213 x 257 x 59

80215-S5D-A01 / 80215-S5D-A02

4 SEASONS



93060

203 x 123 x 35

91110-S04-G11

Non contractual pictures / photos non contractuelles / nicht vertragliche Fotos / fotografie non contrattuali / fotos no contractuales



4 SEASONS



93061
200 x 162 x 25

79110-S6D-G01

4 SEASONS



93063
203 x 178 x 28

79110-S84-A01

4 SEASONS



93070
203 x 178 x 28

79110-S0X-A01 / 79110-S87-A01

4 SEASONS



94692
228 x 165 x 50

79110-SM4-003

4 SEASONS



94693
140 x 50

79110-SF1-003

4 SEASONS



94749
203 x 127 x 50

79110-SH3-A01

4 SEASONS



94750
222 x 127 x 50

79110-SR3-A01

4 SEASONS



94754
207 x 200 x 50

79110-SD4-A01 / 79110-SD4-A02 / 79110-SE0-A01

4 SEASONS



94799
200 x 124 x 50

79110-S04-G01

Non contractual pictures / photos non contractuelles / nicht vertragliche Fotos / fotografie non contrattuali / fotos no contractuales

4 SEASONS

94802
241 x 162 x 41



79110-SV4-A01

4 SEASONS

4 SEASONS

4 SEASONS

33278



80351-SH3-A11

4 SEASONS

33412



80351-SM4-A01 / 80351-SM-1H21

4 SEASONS

33426



80340-SE0-A10 / 80340-SE0-A11 /
80345-SE0-A11 / 80350-SF1-003

4 SEASONS

33569



80351-SV1-A11

4 SEASONS

33574



80351-SV1-A11

4 SEASONS

33577



80351-SS0-H91

4 SEASONS

33588



80351-ST7-A11 / 80351-ST7-003

4 SEASONS

33589



80351-SP0-013

4 SEASONS

33595



80351-501-A01 / 80351-504-003

4 SEASONS

33596



80351-SX0-961

Non contractual pictures / photos non contractuelles / nicht vertragliche Fotos / fotografie non contrattuali / fotos no contractuales



4 SEASONS **33823**

80351-S04-901 / 80351-S84-A01 /
80351-S3M-A01

4 SEASONS **83003**

80351-SDA-A01

4 SEASONS **83008**

80351-SDA-A01

4 SEASONS **83019**

80351-SDA-A01

4 SEASONS **38616**

38650-SA5-003

4 SEASONS **38631**

Matsushita A/C
80220-SM4-A03 / 80220-SM2-A11 /
80220-SR1-A11 / 80220-SS0-003

4 SEASONS **38872**

80220-SE0-972 / 80220-SF1-A01 /
80220-SH3-A01 / 80220-SK-7A01

4 SEASONS **39000**

80220-ST7-A12 / 80220-ST7-A03

4 SEASONS **39002**

80220-SV1-A12

4 SEASONS **39005**

80220-S0X-A01

4 SEASONS **39006**

80220-S5A-G01 / 80220-S5A-G02

4 SEASONS **39007**

80220-S6A-013

4 SEASONS **39020**

80220-S5A-003

4 SEASONS **39021**

80221-SDA-A01

4 SEASONS **39090**

80220-S30-003

Non contractual pictures / photos non contractuelles / nicht vertragliche Fotos / fotografie non contrattuali / fotos no contractuales



Non contractual pictures / photos non contractuelles / nicht vertragliche Fotos / fotografie non contrattuali / fotos no contractuales